

NICKEL

Stainless steel stops
water wastage

From seawater to
drinking water—nickel
alloys make it happen

Nickel-containing arch
to keep Chernobyl safe

August 2016, Vol. 31, No. 2

THE MAGAZINE DEVOTED TO NICKEL AND ITS APPLICATIONS

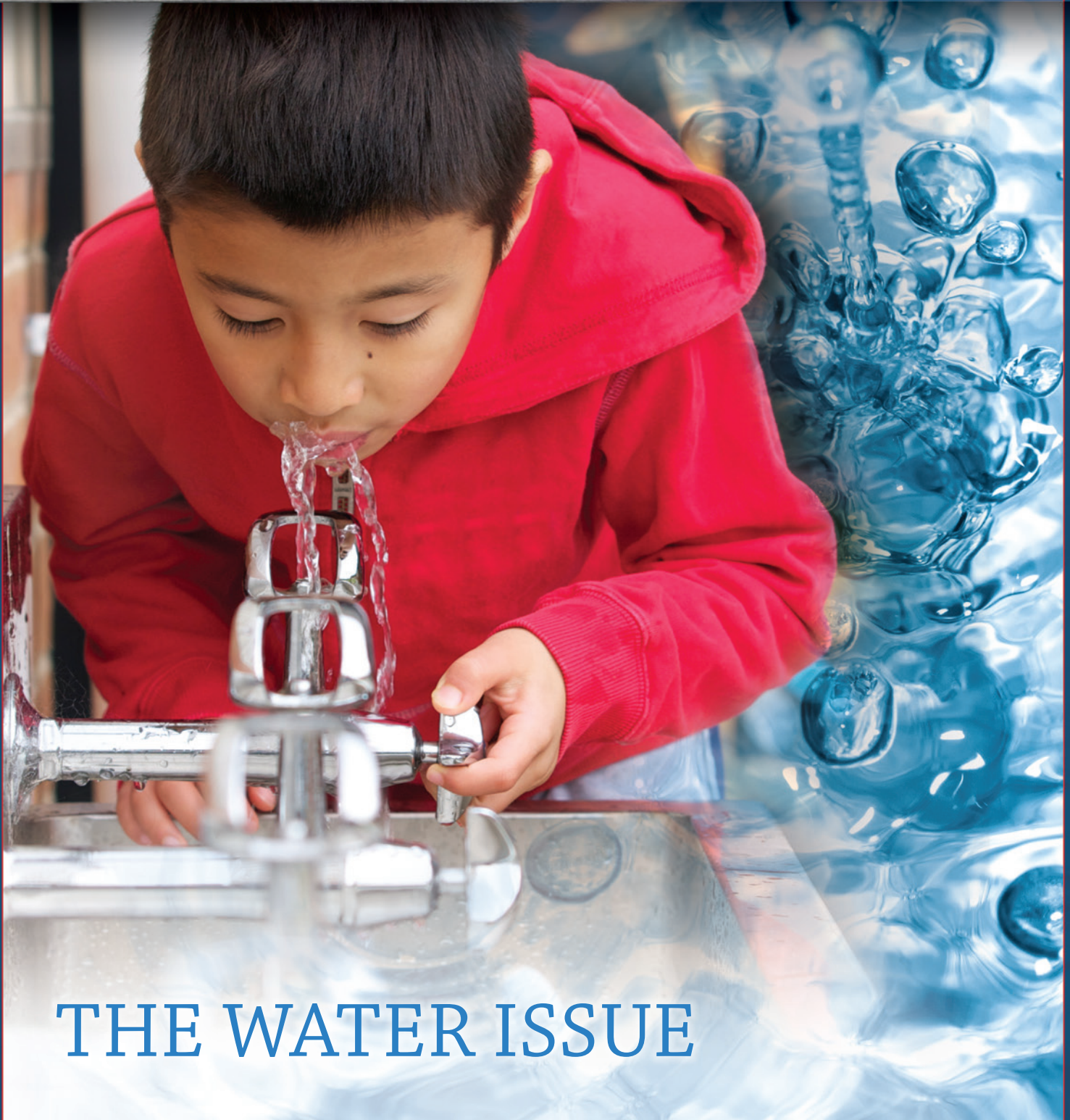

THE WATER ISSUE



△ The wedge shape in the stainless steel grate allows high volumes of water to shoot through.

CASE STUDY 07 THE WATER LABYRINTH

△ *Stainless steel has transformed Perth's historic Forrest Place with a modern, interactive water sculpture.*

The 'Water Labyrinth' in Perth, Australia, was opened in 2012 when the city's historic Forrest Place was redeveloped. The water sculpture provides a stimulating public space for hundreds of thousands of residents and tourists.

Nickel-containing stainless steel was selected for the structure because of its durability and compatibility with the chemical treatment necessary for installation. And its aesthetic and corrosion resistant properties also make it ideal to be specified for water technology applications. Designed in a grid of nine squares, jets of recycled storm water shoot up into the air, creating 2.3m high water walls that randomly rise and fall. These water walls create up to nine 'rooms' that appear and disappear in sequences of ten seconds before changing configuration.

Visitors of all ages leap from room to room or simply have a splash. The Water Labyrinth enables the interaction of people and art while utilising an important public space.

It was designed by internationally renowned artist, Jeppe Hein who says interaction is a distinctive element of the artwork and people play a vital role. "The Water Labyrinth activates the space and invites the public to make use of the artwork, either as a space for seclusion and relaxation or the opposite, a place for pure joy and playfulness." **NI**

LIQUID ARCHITECTURE

An impressive feature of the 12m x 12m Water Labyrinth is the 179m of stainless steel grating and drainage. Fabricated by Paige Stainless, the water sculpture features approximately 62m² of Paige Stainless Heelguard® wedge wire and approximately 160m of 30x5mm flat bar in Type 304 (UNS S30400) stainless steel, supplied by Atlas Steels and Fagersta.

The advanced purpose-designed wedge shape in the stainless steel grates allows high volumes of water to shoot through while trapping waste material for easy removal and cleaning, overcoming inherent problems of drainage.

The grating systems were custom made for the Water Labyrinth with a 5mm gap size and a 4mm wire head width, allowing a 50% open area for water flow. Pickling and passivation treatments were performed on the stainless steel grates prior to installation.

Abridged from an article which originally appeared in Australian Stainless Magazine, issue 53.

NICKEL

The Magazine Devoted to Nickel and its Applications

Nickel magazine is published by Nickel Institute
www.nickelinstitute.org

David Butler, President
Clare Richardson, Editor

Contributors: Tim Aiken, Les Boulton, Fausto Capelli,
John Chapman, Parul Chhabra, Gary Coates, Isaline de Baré,
Richard Matheson, Geir Moe, Kim Oakes, Thierry Pierard,
Lissel Pilcher, Carol Powell, Nigel Ward

Design: Constructive Communications

Nickel Institute can be contacted at:
Rue Belliard 12
Brussels 1040, Belgium
Tel. +32 2 290 3200
communications@nickelinstitute.org

Material has been prepared for the general information of the reader and should not be used or relied upon for specific applications without first securing competent advice. While the material is believed to be technically correct, Nickel Institute, its members, staff and consultants do not represent or warrant its suitability for any general or specific use and assume no liability or responsibility of any kind in connection with the information herein.

ISSN 0829-8351

Printed in Canada on recycled paper by Hayes Print Group

Cover: Constructive Communications
Cover images: iStockPhoto.com © MoMorad,
iStockPhoto.com © Krystian Nawrocki

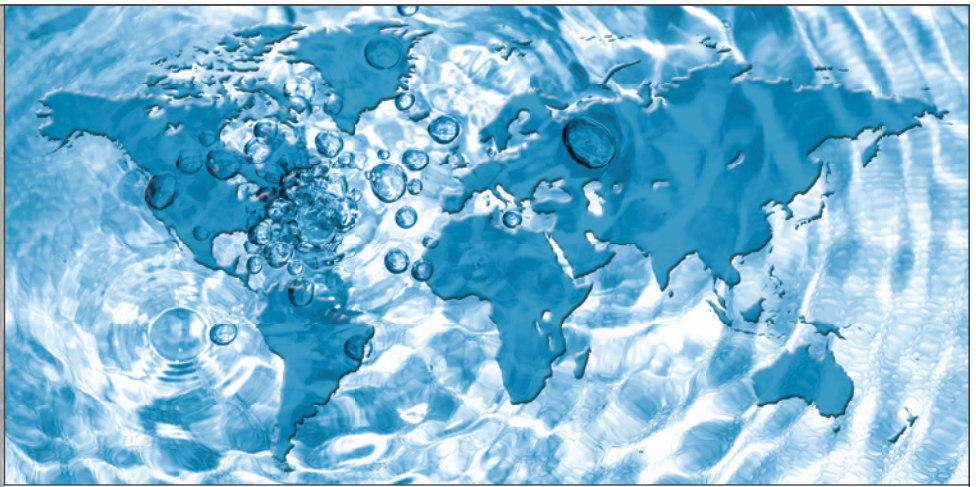

iStockPhoto.com © KRYSZTIAN NAWROCKI

SUSTAINABLE WATER FOR ALL

The recently published World Bank report, *High and Dry: Climate Change, Water and the Economy*, projects that in the next 30 years the global food system will require 40 to 50% more water; municipal and industrial water demand will increase by 50 to 70% and water demand in the energy sectors will increase by 85%. The report also says that 1.6 billion people already live in nations that are subject to water scarcity. And this number is set to double over the next two decades.

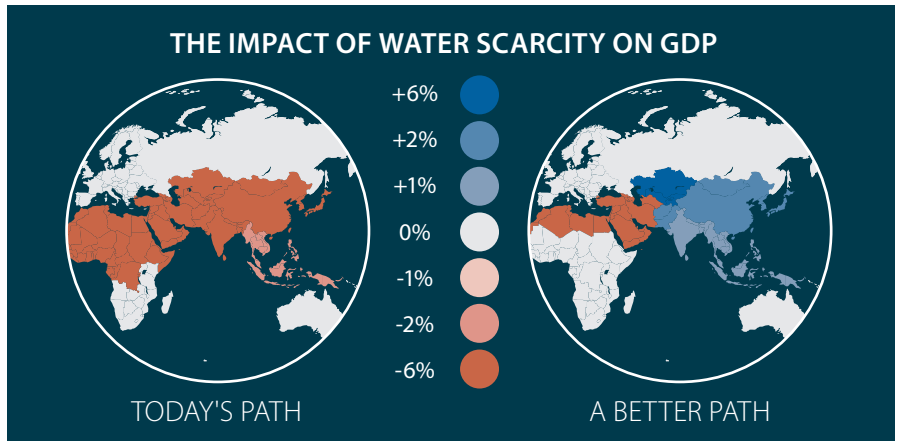

TABLE OF CONTENTS

Case Study

The Water Labyrinth..... 2

In Focus

Editorial..... 3

Feature

Wasting water—a global issue 4-5

Running water 6-7

Nickel and water supply..... 8

From seawater to drinking water 9

In Use

Sewage treatment 10-11

Well pressed with stainless steel..... 11

Containing Chernobyl..... 12-13

Metamorphosis..... 16

In Brief

Replacing noble metals with nickel... 14

UNS details..... 14

Type 316L stainless steel..... 15

New publication 15

Web links 15

All this is brought about by growing populations, rising incomes and expanding cities. However, the report also finds that resilience measures, such as improvements to water infrastructure, can reduce the risks. Water losses across the world are at unsustainable levels. In many developing countries, 50% of water is lost between the water treatment plant and the consumer. Even in developed countries losses above 20% are not uncommon.

Importantly, water is now part of the global development agenda. The UN's Sustainable Development Goals, which apply to all countries, specifically include water. Goal 6 is "Ensure availability and sustainable management of water and sanitation for all" and the aim is to achieve universal and equitable access to safe and affordable drinking water by 2030.

The two big issues for supplying potable water are safety and efficiency. This edition of *Nickel* focuses on the important role that nickel-containing stainless steels already play. Featured on page six is the story of Tokyo which has introduced stainless steel distribution pipework over the past 30 years to replace lead piping and has reduced water loss from over 15% to around just 2%, while at the same time making considerable cost savings.

Nickel-containing stainless steel helps provide safe water, and with a lifetime in excess of 100 years, really does offer a sustainable solution.

Clare Richardson
Editor, *Nickel* magazine

¹ World Bank. 2016. "High and Dry: Climate Change, Water, and the Economy."



The need to stop wasting water is a global issue

What's the problem?

The United Nations has estimated that by 2100, the world's population will have increased to 11.2 billion from today's figure of 7.4 billion. That presents challenges of gigantic proportions: there has to be sufficient and sustainable food, housing, energy and transport, not to mention healthcare. Technology will play a vital part of course, but underlining all of these needs is the requirement to deliver a supply of safe water.

Given the estimates of growth in the global population, there will be insufficient potable water in the world. This stark fact will impact everyone in the long term. Governments, NGOs, the UN, the World Bank and other financial institutions are all actively looking for solutions to this crisis.

The World Bank has estimated that by 2025, water demand will exceed supply by 40%. One of the Bank's recent reports stated that water was the common currency that linked almost all of the UN's Sustainable Development Goals: it is a vital factor in the production of food, in ensuring a healthy population, in guaranteeing the means of production and in maintaining the planet's eco-systems.

Water is being wasted

One reason for the shortage of water is the wastage due to a poorly maintained infrastructure, especially in major cities and the developing world. Leakage from pipes is widespread; for example, in Mumbai there is reportedly a 70% leakage rate. The International Water Association (IWA) has developed an approach that aims to introduce tried and tested methods to reduce losses and increase the quantity of available water from the existing infrastructure on a global basis.

But to overcome the problems of leakage, increasingly water authorities are turning to pipe replacement to stop the leaks for the long term. Nickel-containing stainless steel pipes offer water managers the confidence of a rugged, long life solution to fixing the leaks and providing safe water.

The Water Loss Specialist Group (WLSG) of the IWA has focused on the loss of treated water from leaks in supply networks such as water-mains and water service pipes. The WLSG has developed a method of accounting for the quantity of water entering a water supply system; this has led to the term Non-Revenue Water (NRW) being accepted as the amount of water lost from such a system via leaks, theft and errors in metering, and also points to the economic as well as sustainability implications of the losses.



STAGES OF THE POTABLE WATER CYCLE	ADOPTABLE MATERIALS
Collection	Stainless steel, concrete, galvanised steel, cast iron
Treatment	Stainless steel, concrete, galvanised steel
Storage	Stainless steel, concrete, galvanised steel, polyethylene
Transport	Stainless steel, concrete, galvanised steel, cast iron, polyethylene
End distribution	Stainless steel, galvanised steel, polyethylene, copper
Domestic taps	Stainless steel, brass with chromium plating/ other types of plating

“The World Bank has estimated that by 2025 water demand will exceed supply by 40%.”

Water loss is a major problem. It's estimated that in Asia, many cities are hemorrhaging a third to a half of all treated water; that equates to 60 million cubic metres daily, sufficient water to supply 230 million people. And it is not only in Asia—half of the world's water losses are in Europe and the USA. The cost of NRW to water utility companies worldwide is estimated at US\$14 billion per year.

Treated, desalinated, water is an even more expensive commodity. Waste that and you lose the cost of the chemicals, energy and labour that was required to treat the water in the first place. The cost to the planet and to the water utility companies is enormous.

A solution for the leaks

Blogging on the IWA website, Belgian theorist and activist Michel Bauwens is quoted as saying, “We manage scarce resources as if they were abundant, and we put artificial scarcity on what is actually abundant: knowledge, creativity and innovation.”

Such an innovative approach to maintaining water integrity is seen in many projects that have made extensive use of stainless steel. Indeed, projects that aim to reduce water losses abound. There are strong technical and economic arguments for such projects. For example (see page six), in Tokyo, leakage rates have dropped from more than 15% to just over 2% saving US\$200 million per annum; in Taipei, leakage rates have gone down from 27% to 17% after extensive implementation of stainless steel service pipes. And the Nickel Institute and the International Molybdenum Association are actively pursuing similar projects in other parts of the world.

This urgent need to deliver a sustainable supply of water underlines the necessity to stop any wastage in the current global infrastructure. That is the main thrust in the increased use of stainless steel in water pipes and water treatment plants in many countries. Stainless steel Types 304 (UNS S30400) and 316 (S31600) offer corrosion resistance, strength, ductility and durability. With leakage rates and wastage common in many developing cities and urban areas, the use of stainless steel is a long-term solution that provides cost savings as well as benefits for mankind.

▽ *The urgent requirement to deliver a sustainable supply of water underlines the necessity to stop any wastage from substandard infrastructure.*

Ni

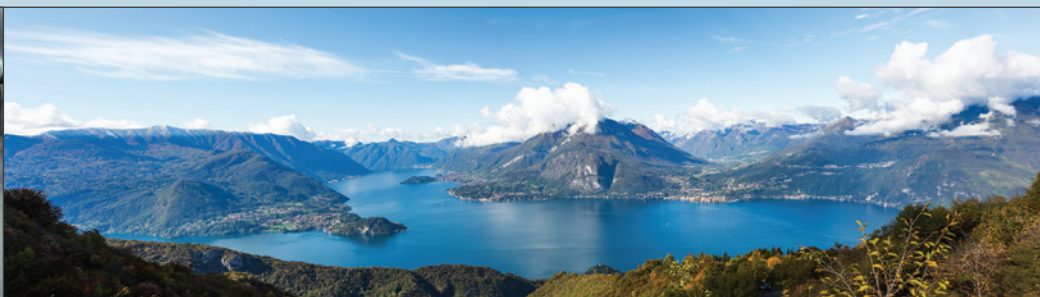

LAKE COMO WATER TREATMENT PLANT

There are an increasing number of stainless steel applications in the potable water sector, due to their corrosion resistance, high durability and low maintenance. The Italian stainless steel development association, Centro Inox, has been heavily involved in many such projects. The Lake Como water treatment plant was built in 2002. The plant has doubled the

previous treatment capacity to 16 million cubic metres, equal to 600 litres per second. 49 tonnes of stainless steel, Types 304 (UNS S30400) and 316 (S31600), were used in the project. The total pipe length was 985m with diameters DN 400/550/700 (16/22/28 inch) and thicknesses of 3 and 4mm. It perfectly illustrates why stainless steel is extremely suitable for potable water applications.

Ni

RUNNING WATER

Water authorities tackle water shortages with nickel-containing stainless steel

Water is a fundamental human need. It is central to our lives, from what we drink, to what we use in washing ourselves, our clothes and a multitude of other uses. Safe, clean and palatable water comes at a price though, and when leaks occur in distribution systems additional costs are incurred as even more water must be found and treated. Security of water supply is a prerequisite for sustainable growth and dealing with leakage is a universal challenge. To combat the scourge of leaks, a number of water distribution authorities across the world have implemented affordable solutions utilizing nickel-containing stainless steel, which not only saves money, but water, a precious resource.



TOKYO SUIDO SERVICE/SHOWARASEKAN

△ Corrugated pipe installation

▽ Correlation between repair cases, leakage rates and installation of stainless steel pipes in Tokyo

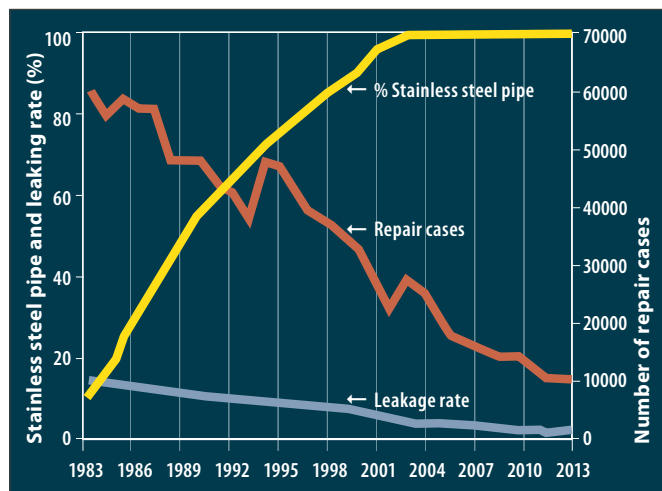

BUREAU OF WATER WORKS, TOKYO METROPOLITAN GOVERNMENT

Tokyo, Japan

Prior to the 1980's, water shortages in Tokyo were chronic and rationing was occasionally required. When the city's water provider, the Tokyo Metropolitan Government Waterworks Bureau (TMGWB), analysed leakage repairs, they determined that 97% were on the distribution pipes of 50mm diameter or less. In Tokyo, there are more than two million such connections that take the water from the mains to internal systems in buildings. Historically, lead pipe was the preferred material for distribution lines because it is soft, malleable and easy to work with, especially for the last few metres from the mains to buildings. Once lead pipe is in the ground, however, various forces can act on it. Vibrations from traffic and construction work as well as subsidence and earthquakes can cause the soft lead pipes to deform, become detached or even break.

In 1980, TMGWB started to actively replace all service connections with Type 316 (UNS S31600) nickel-containing stainless steel pipe. In 1998 corrugated Type 316 (S31600) stainless steel pipe was introduced for distribution lines that take water from the mains to final destinations in homes, offices and industrial plants. The pipe is corrugated at regular intervals to allow for it to be bent during installation, to accommodate changes in direction and the avoidance of obstacles without additional joints. It also allows for movement of the pipe during earth movement and seismic events. By supplying a single length of corrugated stainless steel pipe, the number of pipe joints was greatly reduced. In switching to stainless steel pipe, the reliability of the water supply has increased and the leakage rate has been reduced by 86% from 15.4% (1980) to 2.2% (2013). To put this into context, since 1994 Tokyo has reduced annual water leakage by nearly 142 million cubic metres—the equivalent of 155 Olympic-size swimming pools per day, with savings in excess of US\$200 million per year. Also, annual leak repairs have decreased from 60,000 (1983) to 10,000 (2013). Due to the corrosion resistance of stainless steel, TMGWB expects service life in excess of 100 years.

Taipei, Taiwan

In 2002, a severe drought brought intermittent water supplies to the Taiwanese capital over a 49-day period. Of the 450 metering areas in the city, 40% were losing half of their water or more before it reached consumers.

Analysis of repair cases showed that while polybutylene pipe made up only 3% of the length of the system, it accounted for 28% of all leaks. Approximately 90% of all problems occurred in plastic pipes, with the vast majority (83%) caused by cracking.

In 2003, the Taipei Water Department began a similar program to Tokyo, replacing distribution lines with corrugated Type 316L (S31603) stainless steel pipe. Although the ongoing program has so far only replaced 35% of the lines, the result has been a reduction in water loss from 27% (2003) to 17% (2014). This adds up to an annual saving of 146 million cubic metres of water, the equivalent of 160 Olympic-size swimming pools per day.

In 2014, a drought occurred with even less rainfall than the 2002 event which precipitated the pipe replacement program. However this time, the improvement in leakage rates achieved since 2003 meant there was no interruption to the water supply.

▽ *The 2002 drought in Taipei caused severe water shortages.*



Western Cape, South Africa

South Africa is by nature a semi-arid country; its annual rainfall is only half the global average. It has a population of 55 million and is facing freshwater scarcity. It is estimated that at least 37% of its clean drinkable water is lost due to leakage from old and unreliable infrastructure.

The Groot Drakenstein Valley is the cradle of the South African deciduous fruit and wine industries. Water is supplied to over 800 farms including 50 vineyards. Here, there are numerous examples of carbon steel and cast iron pipes that have failed in many areas after just one year due to the very aggressive acidic soils and high water table. “We started a project in 1992 in the Drakenstein Municipality to replace existing piping with stainless steel,” explains André Kowalewski, Senior Engineer – Water Services, Drakenstein Municipality. “We have reduced water loss to around 13% in comparison to the 37% national average. Ten years back only the Drakenstein Municipality used stainless steel. Now 80% of the Western Cape municipalities do.”

André and his team plan for a life expectancy in excess of 50 years. Stainless steel used in Drakenstein is primarily Type 316 and in some cases Type 304 (S30400) in visible locations. Projects are currently focussed around pumping, purification, storage, pipelines and sewage. One such project is a 500 mega-litre/day delivery system completely in Type 316 stainless steel.

Investing in the future

The experience of Tokyo, Taipei and the Western Cape gives water authorities the confidence to specify nickel-containing stainless steel for piping systems. While the initial cost compared to competing materials may be higher, stainless steel has been shown to be a good investment over its long life, paying back each year in reduced maintenance and cost per litre processed. **Ni**

▽ *Stainless steel pipe in the Western Cape resists aggressive acidic soil conditions.*





WASTE NO WATER

THE ESSENTIAL ROLE OF NICKEL

By 2025, the World Bank has estimated that water demand will exceed supply by 40% as the world's growing population requires more water for agricultural, industrial and personal use. Nickel-containing materials are essential to preserve this precious resource. Poorly maintained and ageing infrastructure are common problems in nearly all major cities in both the developed and developing world, causing extensive water wastage. Nickel-containing materials provide solutions and assist at every step of the water system from collection to distribution.

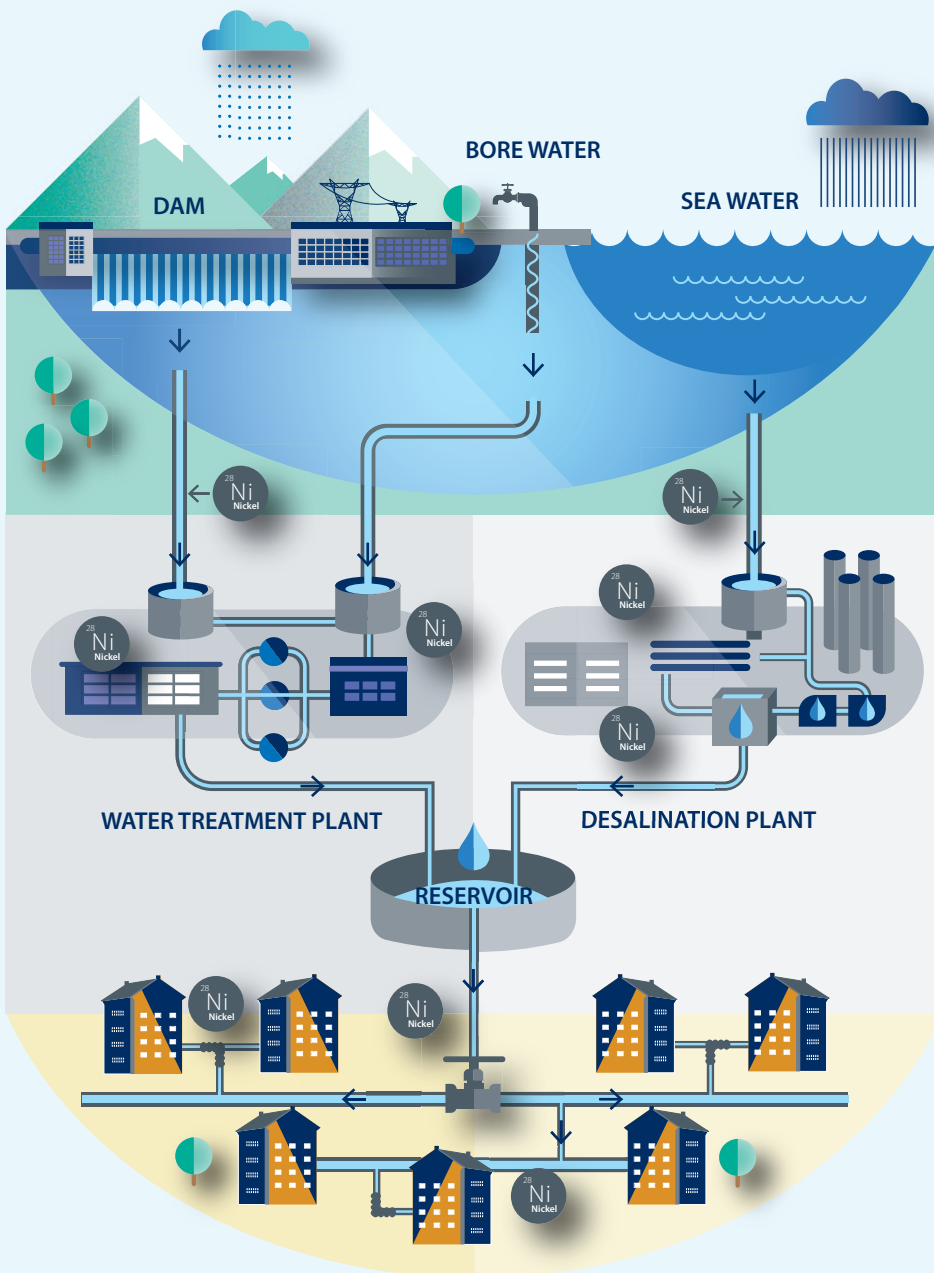

WATER COLLECTION

Nickel-containing stainless steel is used throughout the water collection process. Its corrosion resistant properties make it the material of choice for penstocks, dam gates, bore filters and subsea intakes.

WATER TREATMENT

After collection the water is treated. Stainless steel and high nickel alloys are ideally suited for high pressure pipework, valves, penstocks, pumps and other vital components. For the treatment of seawater, nickel-containing materials are essential to combat the extremely corrosive conditions of desalination plants. Many tonnes of nickel alloys and stainless steel are found in a water treatment plant and play a central role in providing safe water.

WATER DISTRIBUTION

Many leaks in the water distribution system occur in the service pipes leading from the mains supply to buildings. Nickel-containing stainless steel is the best choice for the replacement of service pipes thanks to its outstanding properties of corrosion resistance, strength and ductility. The use of stainless steel substantially reduces leakage rates and maintains water integrity by preventing contamination in the pipes. It can tolerate moderate earth movement from seismic events, heavy traffic or construction. Nickel-containing stainless steel provides a low-maintenance infrastructure with a very long life.



△ Background: Reverse osmosis modules △ Top: Filtered seawater pipe in super duplex stainless steel
△ Bottom Inset: Seawater piping connections in super-duplex stainless steel



From seawater to drinking water

How nickel-containing alloys play a role in the global solution

As much as 40% of the global population is affected by potable water shortages. Not only does it have to be safe to drink, all countries need fresh water to support agriculture. Yet a very high proportion of our world's water reserves are salty or brackish and not fit for human consumption.

The solution? Desalination of seawater that is readily available from oceans has been an established technology for many decades. Today, development of that technology is growing rapidly in response to a steadily increasing global population.

Nickel alloys and nickel-containing high alloy stainless steels are playing a key role. These alloys have the right combination of properties to resist the extremely corrosive conditions that prevail in desalination plants.

The drive to desalinate

Modern desalination plants operate by utilising either distillation or reverse osmosis of seawater.

In thermal distillation plants, seawater is heated and evaporated to produce distilled water which is clean and safe to drink. The technologies most commonly employed are multi-stage flash (MSF) or multiple-effect distillation (MED).

In reverse osmosis (RO) plants, high pressure pumps are used to drive sea water through a membrane that permits clean desalinated water to pass through, but blocks the passage of dissolved salts found in seawater.

For both of these desalination technologies, the plant construction materials employed require high strength and excellent corrosion resistance.

Alloy answers under pressure

The older seawater distillation plants widely used copper-nickel alloys such as 90Cu-10Ni (UNS C70600) and 70Cu-30Ni (C71500) for many of the desalination plant elements.

The current interest around the world in larger RO plants requires construction materials that can perform well at high pressures and in corrosive seawater for up to 40 years. RO plants operate in pressurised seawater up to 90 bar and, temperatures up to 40°C, with biological contaminants and chlorine additions up to 30ppm.

Under these conditions, the standard austenitic and duplex stainless steels have experienced some localised corrosion attack, particularly crevice corrosion at pressurised seawater pipe flanges.

To overcome this, modern RO plants are constructed from nickel-containing super-austenitic and super-duplex stainless steels. Alloys in the 6Mo family (e.g. N08367 and S31254) and the super-duplex family (S32750 and S32760) are particularly well suited to deliver the long life for piping and fabricated components in a wide range of desalination plant environments.

The superduplex alloys have similar corrosion resistance to 6Mo super-austenitic stainless steel, but the duplex alloy has the added benefit of higher strength and improved fatigue resistance making it a more optimal material for high-pressure seawater feed piping and brine pumps.

These high alloy stainless steels are now being extensively used in RO desalination plants around the world, in efforts to reduce potable water shortages in the future. **Ni**

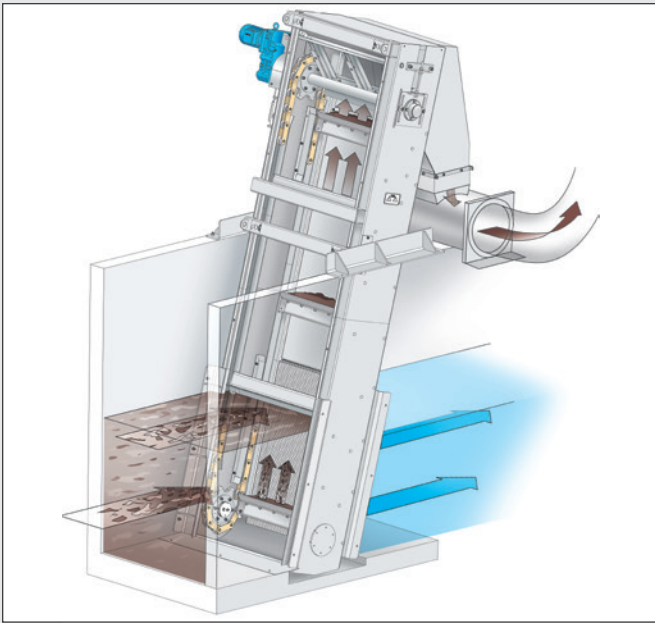

△ HUBER Multi-Rake Bar Screen RakeMax® screen positioned within intake flow and showing screenings extraction

Giving sewage the stainless steel treatment

Sewage treatment is a process that most people in developed countries take for granted. It's a topic that many of us may choose not to dwell on, yet effective processing of waste water is essential for the health of both humans and the environment. When sewage arrives at a waste water treatment plant, it is a nasty liquid mix of food materials, human waste, detergents, fats, oils and greases, as well as other waste chemicals and debris. At the sewage treatment works (STW) it undergoes a process of screening, settlement, oxidation and disinfection until it is sufficiently clean, to be discharged back into the natural environment. Nickel-containing stainless steels

play an increasing role in these plants (see table, page 11). Stainless steel Types 304 (UNS S30400) and 316 (S31600) and their low carbon variants are the principal alloys used, with duplex alloy 2205 (S32205) used where particularly severe conditions are anticipated or extra strength/decreased thickness is required. Stainless steel is ideal for numerous applications throughout the process including machinery for screening, washing, compacting, grease and oil separation, thickening and dewatering of various types of screenings and sludge as well as sieve filtration, ozone and UV equipment.

Meadowhead Sewage Treatment Works

The Meadowhead Sewage Treatment Works in Scotland has recently selected a stainless steel solution in its inlet works facility. Inlet screens are used to remove solid materials that would interfere with subsequent downstream processes. After removal, the screenings are treated, often by washing and compacting, and collected for disposal. Meadowhead STW serves a population of 220,000 and the six large pumping stations within the catchment area handle flows for the plant between 1,000-5,500 litres/sec. The existing works inlet had consisted of both fine and coarse screening areas which had to contend with the large variations of flow. With unacceptably high levels

▽ Example of municipal wastewater treatment processing
Stainless steel can be used for various equipment and piping systems throughout the plant.

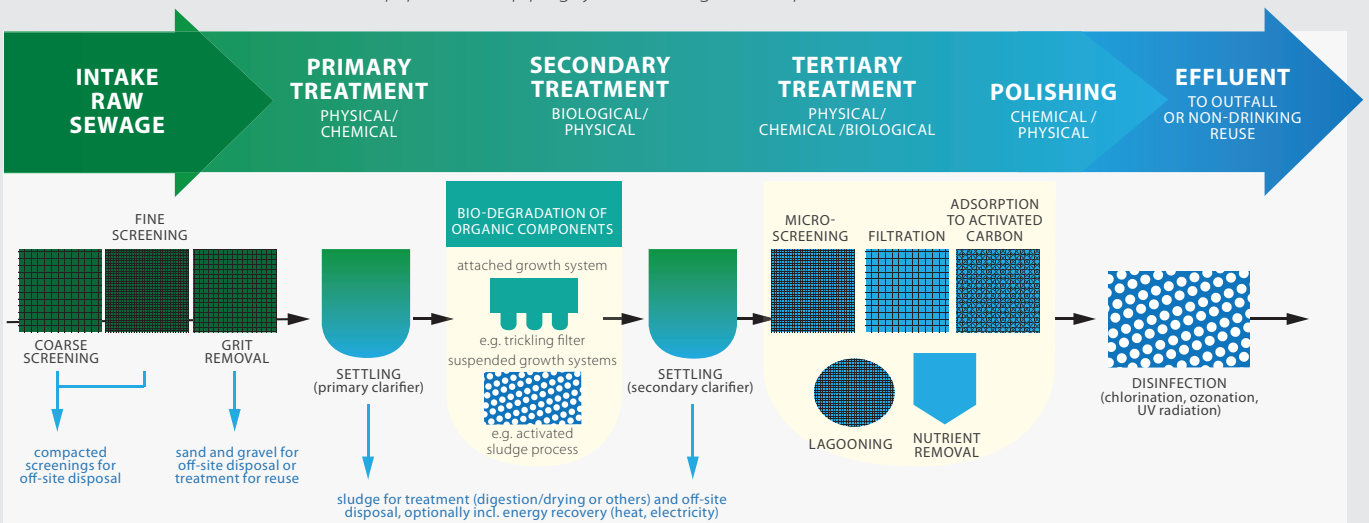



△ Screens installed at Meadowhead STW

of maintenance to the old screens, a new solution was required. Potential solutions were explored to solve issues of high screenings removal rates, improvement to the equipment reliability, and to fit any new equipment within the limited space of the existing building with minimum disruption. Scottish Water chose to install four large, HUBER Multi-Rake Bar Screen RakeMax®, coarse screening units as well as four HUBER Screenings Wash Presses WAP-L, all manufactured and designed by Huber Technology in Type 304 stainless steel. The multi-rake coarse bar screens are 6,300mm long, 2,752mm wide with 19mm bar spacing each handling 2,200 litres/sec per screen. These have a high screenings removal capacity and it was possible to retrofit them into the existing inlet works.

To reduce delivery times, the multi-rake screens were shipped in sections and reassembled on site and deployed through the roof of the building. "As Huber Technology are experienced manufacturers of stainless steel machines for waste water treatment, we were confident that the strength and the flexibility of the design would allow reassembly at the treatment works," says Steve Morris, MD, of Huber Technology. "Although a challenging task, the relatively light weight allowed ease of lifting to reposition the screens within the building." Since the installation in 2014, several large storms have already been experienced and all units are working well. NI

**Typical Stainless Steel Applications
in Waste Water Treatment Plants**

Hand rails	Walkways
Screens	Travelling bridges
Grit removers	Scrapers
Slide gates	Bolts
Aeration piping	Pumps and valves
Sludge transfer piping	Tanks
Digester gas piping	Weirs
Ozone generators and piping	Ultraviolet equipment
Chemical treatment lines	Ladders
Manhole covers	Ducting
Backwash systems	Membrane housings

Well pressed with stainless steel

Speedy and durable mechanical joining technique for stainless plumbing systems

Pressfitting has advantages over traditional pipe work joining methods such as soldering and welding. This makes it an increasingly desirable choice for metal plumbing applications, with the benefit of speed of connection and the convenience of cold joining. The technique uses a pressing tool comprising a pressing unit with matching jaws or collars to compress O-rings sitting within special pressfit connections onto piping to form a complete seal. The jaws of the pressfit tool can be rotated into tight spaces, making the system ideal for use on retrofit projects and complex installations.

Stainless steel has lent itself to pressfitting manufacture and is used to install supply systems including potable water, fulfilling stringent requirements and low leaching levels for the conveyance of drinking water in both public and commercial buildings. Due to its high corrosion resistance, strength and ductility, it can also be used for a wide variety of other applications involving corrosive or aggressive media.

One recent project where the benefits of pressfitting in stainless steel were realised was the Wellcome-Wolfson Institute at Queens University, Belfast. Located on the Health Science Campus at Belfast City Hospital, many of the building services installed deal with specific laboratory environment challenges, such as chemicals and high temperatures. The system, constructed from Type 316 (UNS S31600) stainless steel, was specified for the building's low temperature, hot water and chilled water systems, mist fire suppression system and natural gas. NI

GERBERT

▽ A Geberit Mapress stainless steel pressfit system installed at at the Wellcome Wolfson Institute, Belfast



▽ Pressfitting being sealed onto piping using an electro-mechanical pressing tool. The pipe and pressfitting diameters span from 15 to 108mm diameter for this system. The fittings feature a blue pressing indicator that is removed as part of the correct pressing procedure so that any missed joints can be quickly identified.





△ The New Safe Confinement shelter has been designed to provide protection for a century or more.

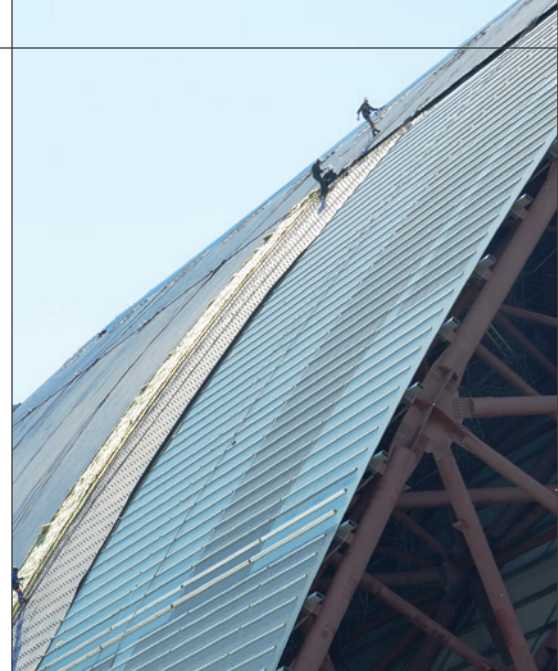

△ Technical alpine skills were necessary to install the external cladding.

©CHNPP

CONTAINING CHERNOBYL

Nickel-containing stainless steel to defy time, climate hazards and radiation

Covering Chernobyl nuclear reactor Unit 4, destroyed in a catastrophic accident in 1986, the New Safe Confinement (NSC) will soon put an end to the alarming degradation of the concrete and steel sarcophagus installed after the disaster. As of 2017, the majestic airtight, seismic-resistant steel arch, capable of withstanding extreme climate conditions, is due to defy both time, climate hazards and the invisible but still insidious and long-lasting threat of radioactivity.

Nickel-containing stainless steels are an essential component of the new shelter. It has been designed to allow the damaged reactor to be safely dismantled and tons of radioactive debris to be removed after a compulsory hundred-year safety period, as well as protecting technical personnel from harmful radiation exposure during on-site maintenance activity.

Preventing corrosion versus fighting it

Weighing 25,000 tons, 108m high, 162m long and 257m wide, this mammoth structure will be tall enough to enclose the Statue of Liberty and will weigh four times more than the Eiffel Tower.

The NSC comprises 15 primary arch frames, forming a 12m thick three-dimensional tubular lattice that shapes the elegant final arch. Fabricated from four hundred 813mm diameter round carbon-manganese steel tubes of similar quality to that of offshore oil rigs, this lattice creates an “annular space” that is completely wrapped—inside and out—with a stainless steel cladding. Once the arch is in place above the damaged reactor, two

cladded metallic walls will be unfolded at each end. They will precisely fit the sarcophagus’ profile, hermetically sealing the building for a century.

Durable and reliable confinement against contaminated dust and radioactive emissions will be achieved by maintaining a permanent slight overpressure while the volume under the arch will be maintained under negative pressure. Dehumidified air will be continually blown into the annular space in order to maintain a constant hygrometric level below 40% that will naturally prevent corrosion of the metallic lattice.

Non-magnetic stainless to prevent dust accumulation

Nickel-containing stainless steels were a natural choice for the inner and outer claddings given their durability, high corrosion-resistance with mechanical strength, and the advantage of being maintenance-free in such an exposed area.

The inside cladding is a Type 304 (UNS S30400) stainless steel, with minimum 8.0% nickel, a non-magnetic grade

to prevent the accumulation of contaminated dust that would be hazardous inside the arch when the time comes to dismantle it. Over the entire surface of the vault, 80,000m² of 0.5mm thick stainless sheets are tightly fitted without ribs to avoid collecting dust.

The sheets are fixed on a galvanized steel deck. Air-tightness is ensured by non-PVC tape seals and fire resistant silicone mastic, insensitive to ionizing radiation. A polyester paint provides galvanic corrosion prevention between the sheets and the decking. A bright-annealed highly reflective finish has been used in order to enhance natural brightness inside the arch.

316L to withstand climate hazards

Outer cladding forms an impenetrable barrier against external climate hazards. It is equipped with an insulating complex aimed at meeting the stringent resistance specifications for the most severe climatic conditions.

The top slice of this highly efficient insulating sandwich is covered with 88,000m² of 489mm wide, 0.6mm thick Type 316L (S31603) with minimum 10.0% nickel, stainless steel profiles. The choice of Type 316L grade was decisive to fully meet the requirement of this unprecedented 100-year long (and beyond) exposure to climate hazards.

Multiple-step construction

Radioactive emissions have made it necessary to pre-assemble the arch on the ground at a safe distance of 200m from the damaged reactor building. When the entire structure is completely assembled, synchronized “skid shoes” on concrete ground beams will slide the arch over 300m to its final position above Unit 4 building.

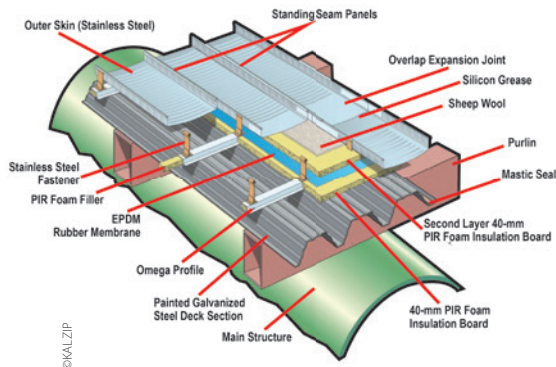
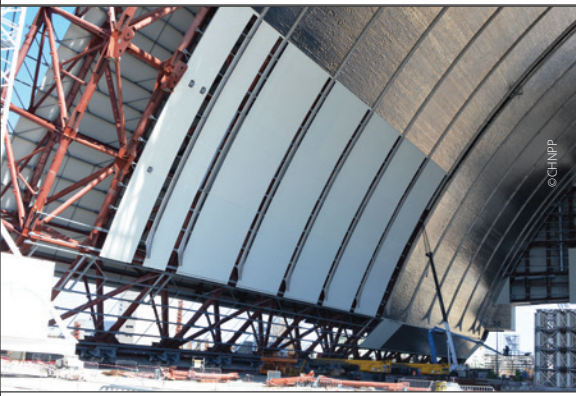

△ Installation of the internal cladding

△ Outer cladding: an efficient multi-layer insulating sandwich

Roll forming at the foot of the arch

Types 304 and 316L stainless steels were supplied by Aperam and delivered to the worksite by Kalzip in 1,000m long coils. They were processed at the foot of the arch in two in-container mobile production facilities. 316L coils were cold roll-formed into 100m long profiles for the roofing of the arch and 50 to 70m long profiles for the cladding of the walls.

The profiles were then transported by crane into their installation position. Standing seam profiles are positioned and clipped into previously installed Type 304 stainless fasteners ('halters'), the next, profile being immediately brought into position with the larger seam overlapping the smaller one. Fasteners are mounted through the rubber membrane on omega profiles by means of 316L self-tapping screws. Finally, a special seaming machine then crimps all profiles together over their total length. This mounting technique will enable the outer cladding to withstand class 3 tornadoes (severe damage), winds topping 250km per hour and temperatures ranging from -45°C to 45°C.

With this feat of engineering, nickel-containing stainless steels will help protect workers, the local population and the environment for a century or more. **Ni**

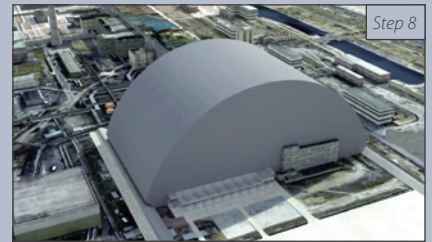
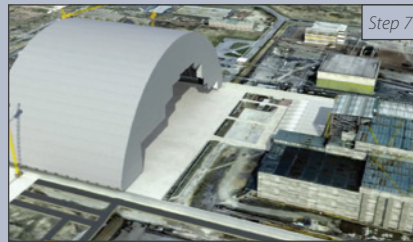
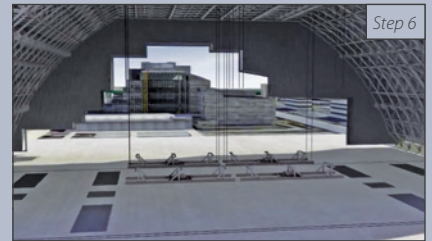
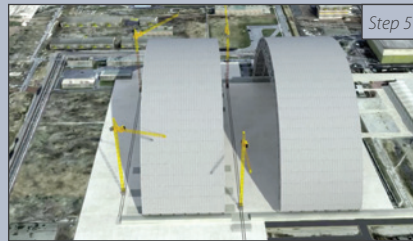
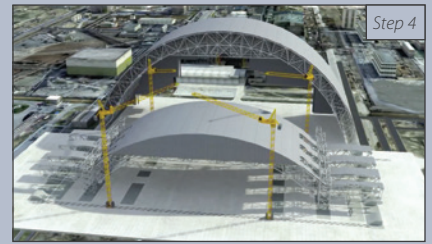
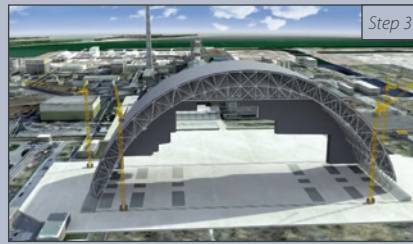
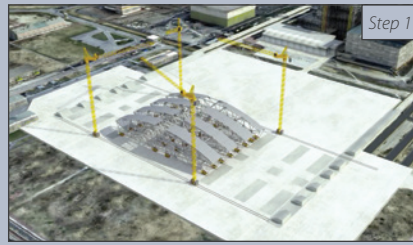

- Step 1** Assembly of the upper section of the first half arch.
- Step 2** Assembly of the lower section that is then connected to the upper section using a hinge system.
- Step 3** The first half arch is lifted to its final height (105m) using towers designed to lift loads of several thousand tons. The eastern wall—shaped to fit the reactor building profile—is installed. The completed first arch is then pushed to a waiting position to make room for the second half arch.
- Step 4** Assembly of the second half arch.
- Step 5** The two halves are connected to form the complete arch.
- Step 6** Overhead bridge cranes are assembled on the ground and then lifted to the arch structure 85m above. They will be used for dismantling the old sarcophagus and removing the debris of the damaged reactor.
- Step 7** Synchronized “skid shoes” on concrete ground beams will slide the arch over 300m to its final position.
- Step 8** The arch and side walls are tightly connected to the existing building. The western facade will host the information and control center.

Replacing noble metals with nickel

Chemical synthesis can transform commodity chemicals into complex life-saving drugs, household products, or advanced materials. But this “alchemy” can also produce huge amounts of toxic waste or require harsh and dangerous conditions—and often relies on expensive and rare metals to spark reactions.

In recent reports in the journals *Dalton Transactions* and the *Journal of the American Chemical Society*, the research team of Liviu Mirica, Associate Professor of chemistry in Arts & Sciences at Washington University in St. Louis, has developed novel methods for generating the building blocks of important compounds with nickel.

More efficient

The work expands scientists’ toolbox for nickel-based chemistry. It contributes to the movement of “green chemistry” toward a 21st century of sustainable synthesis, with chemical transformations that are more efficient, produce fewer by-products and, most importantly, create less waste.

Mirica’s lab researches how to create these new compounds in as few steps as possible and with more sustainable catalysts, like nickel.

Carbon-hydrogen (C-H) bonds are considered unreactive and can be difficult to coax into creating a new carbon-carbon (C-C) bond. So chemists like Wen Zhou, the postdoctoral scholar, who is the first author of the two recent reports, rely on metals to “activate the bond,” and make it more reactive.

The rare metals palladium and platinum have been used for decades, but are expensive. Nickel, in the same chemical group, could be used for similar reactions if its properties were understood better.

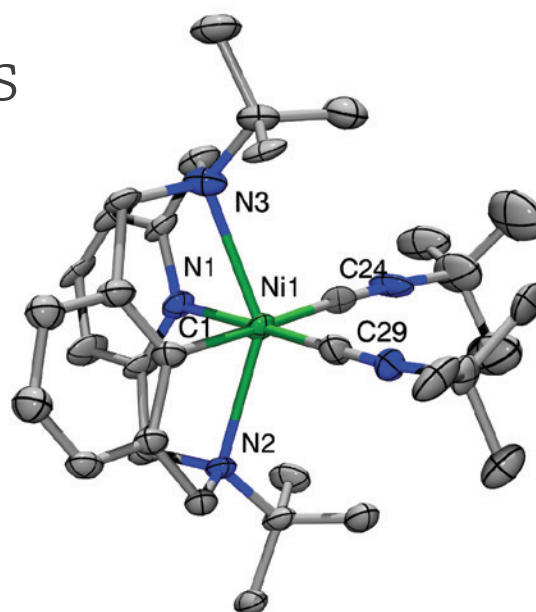

△The new four-pronged molecule is known as a tetradentate ligand. New nickel-based chemistry condenses chemical synthesis into fewer steps and provides an alternative to metal catalysts.

New four-pronged molecule

The scientists’ key development was the creation of a new four-pronged molecule, known as a tetradentate ligand, which acts like the pocket of a baseball glove to grasp the nickel atom. When carbon-containing compounds also bind to the nickel centre, the electrons can reposition to form a new C-C bond.

The right balance of stability and reactivity allowed the scientists to create new bonds with inexpensive, safe and abundant nitriles, a class of carbon-containing compounds that can be turned into a whole range of useful chemical groups in simple synthetic steps.

The hope is nickel could replace the more costly rare metals that have been used for years in the chemical industry. Ni

UNS details Chemical compositions (in percent by weight) of the alloys and stainless steels mentioned in this issue of *Nickel*.

UNS No.	C	Co	Cr	Cu	Fe	Mn	Mo	N	Ni	P	S	Si	W	Zn
C70600 p. 9	-	-	-	bal.	1.0-1.8	1.00 max.	-	-	9.0-11.0	-	-	-	-	1.00 max.
C71500 p. 9	-	-	-	bal.	0.4-1.0	1.00 max.	-	-	29.0-33.0	-	-	-	-	1.00 max.
N08367 p. 9	0.030 max.	-	20.0-22.0	0.75 max.	bal.	2.00 max.	6.0-7.0	0.18-0.25	23.5-25.5	0.040 max.	0.030 max.	1.00 max.	-	-
S30400 p. 2,5,7,10,12,15	0.08 max.	-	18.0-20.0	-	bal.	2.00 max.	-	0.10 max.	8.0-10.0	0.045 max.	0.030 max.	0.75 max.	-	-
S30403 p. 15	0.03 max.	-	18.0-20.0	-	bal.	2.00 max.	-	0.10 max.	8.0-12.0	0.045 max.	0.030 max.	0.75 max.	-	-
S31254 p. 9	0.020 max.	-	19.5-20.5	0.50-1.00	bal.	1.00 max.	6.0-6.5	0.18-0.22	17.5-18.5	0.030 max.	0.010 max.	0.80 max.	-	-
S31600 p. 5,6,7,10,11	0.08 max.	-	16.0-18.0	-	bal.	2.00 max.	-	0.10 max.	10.0-14.0	0.045 max.	0.030 max.	0.75 max.	-	-
S31603 p. 7,12,15	0.030 max.	-	16.0-18.0	-	bal.	2.00 max.	2.00-3.00	0.10 max.	10.0-14.0	0.045 max.	0.030 max.	0.75 max.	-	-
S32205 p. 10	0.030 max.	-	22.0-23.0	-	bal.	2.00 max.	3.00-3.50	0.14-0.20	4.50-6.50	0.030 max.	0.020 max.	1.00 max.	-	-
S32750 p. 9	0.030 max.	-	24.0-26.0	0.50-max	bal.	1.20 max.	3.3-5.0	0.24-0.32	6.0-8.0	0.35 max.	0.020 max.	0.80 max.	-	-
S32760 p. 9	0.030 max.	-	24.0-26.0	0.50-max	bal.	1.00 max.	3.0-4.0	0.20-0.30	6.0-8.0	0.030 max.	0.010 max.	1.00 max.	0.50-1.00	-

TYPE 316L: Corrosion resistant and readily available

Type 316L (UNS S31603) is the second most commonly produced alloy in the 300 series after Type 304 (S30400) and its variants.

In environments where 304 or its low carbon version, 304L (S30403), are found to be inadequate, 316L is the first grade that should be considered. Typically, this grade is used extensively in environments where chlorides are present (e.g. road salts, coastal areas) and similarly in process industries requiring acidic or higher temperature solutions. Some older names for 316L include the “marine grade” or “acid-resistant grade.” Like all nickel-containing austenitic stainless steels, 316L has excellent welding and forming characteristics.

Corrosion resistance and fabricability

While the chromium content is slightly lower than in 304, it is the 2.0% minimum molybdenum (Mo) that greatly improves the corrosion resistance of 316L, with increased pitting and crevice corrosion resistance in chloride-containing solutions. The exact composition varies slightly between the various international standards, but the 10.0% minimum nickel content ensures that the steel remains fully austenitic, with optimum corrosion resistance and ease of fabrication.

Some of the many thousands of applications of 316L are found in pharmaceutical, chemical and biochemical processing, pulp and paper, offshore and onshore oil and gas, architectural applications in urban and coastal locations, food processing, hospitals, potable water and sewage treatment, and transport containers.

▷ Made from Type 316L, artist Andy Scott's Kelpies tower thirty metres above the Forth and Clyde canal in central Scotland.

Type 316L is not only easy to fabricate, offering versatility with good corrosion resistance in a broad range of environments with a long track record of use, but it is also widely available in all product forms in large and small quantities, direct from the mill or from stockholders. **Ni**



HELIX WWW.THEHELIX.CO.UK

New Ni publication **The life of Ni**

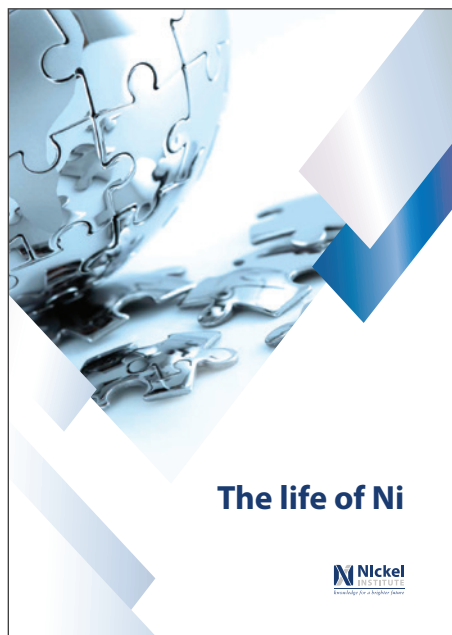

The life of Ni is a handy reference for anyone interested in nickel, its origins, uses and life cycle. This 20-page publication provides a concise and highly visual presentation of global nickel facts and figures and reveals where and how much nickel is mined, produced and used, available nickel resources, and how it is recycled. **Ni**

Download from nickelinstitute.org or request a printed copy from communications@nickelinstitute.org

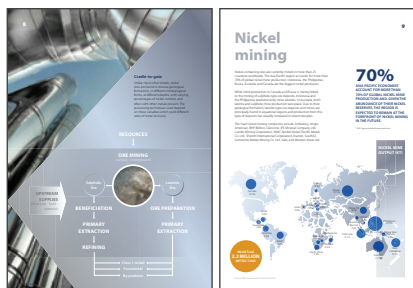

NICKEL MAGAZINE ONLINE

www.nickelinstitute.org

SUBSCRIBE to *Nickel* magazine free of charge and receive a printed copy or an e-mail notice when a new issue is posted online. www.nickelinstitute.org/NickelMagazine/Subscription

READ *Nickel* magazine online in several languages. www.nickelinstitute.org/NickelMagazine/MagazineHome

SEARCH BACK ISSUES of *Nickel* magazine from our online archive, going back to July 2002. www.nickelinstitute.org/en/NickelMagazine/MagazineHome/AllArchives

MOBILE Download the *Nickel* magazine app for your Apple® or Android™ device.

FOLLOW US on Twitter @NickelInstitute

JOIN US on LinkedIn—visit the Nickel Institute's page

WATCH nickel related videos on the Nickel Institute YouTube channel www.youtube.com/user/NickelInstitute

METALMORPHOSIS

A SHINING EXAMPLE OF THE CHEEKY SIDE OF DAVID ČERNÝ

Constructed at the Whitehall Technology Park in Charlotte, North Carolina, *Metalmorphosis*, is a mirrored water fountain by controversial Czech sculptor David Černý.

Notorious for his rebellious, politically charged, large-scale, interactive sculptures, Černý has a seemingly tame yet cheeky message with *Metalmorphosis*. If you look deeper into the layers of this sculpture, *Metalmorphosis* seems to offer up several nods to Černý's rebellious side. As the layers rotate independently they create almost eerie and unrecognizable forms. And as they come together they create a face that spits water from its mouth.

This 7.6m high, 14-ton sculpture is made from massive nickel-containing stainless steel layers, primarily Type 304 (UNS S30400)

for durability and long life. The creation consists of nearly 40 steel pieces grouped into seven segments that rotate 360-degrees. Custom-written programs control the motors of each segment and are choreographed and controlled by Černý himself through the internet. The image, with its highly polished stainless surface, is reflected in the pool of water below the sculpture. And the internal plumbing is comprised largely of stainless steel as well. As for his inspiration, he notes that it is 'something of a self-portrait' of his own psyche. *Metalmorphosis* even has its own live webcam. **Ni**

▽ *Metalmorphosis* consists of nearly 40 pieces grouped into seven segments which rotate independently.

